





**Guide to Handrail
& Building Codes
and
Safety
Standards**



**CERTIFIED
STAIRS.**



Committed to
Providing Superior
Value to Our
Customers

Safety Management Systems

CertifiedStairs.com
407 476 8565

Table of Contents

Handrail and Guard Code Issues

It is important to confirm all code issues with local authorities since many have not updated their requirements to currently available model codes. Prior to using any railing products, it is incumbent on designers, fabricators and installers to make themselves familiar with local codes that apply to their applications. This document will provide information to guide you in your understanding of the existing codes and standards and how they may apply

A code comparison chart is included at the back of this document which provides key information relating to guard and handrail listed in various codes.

Table of Contents

Code Bodies and Standards

International Code Council (ICC)	1
International Residential Code (IRC)	
International Building Code (IBC)	
National Fire Protection Association (NFPA)	1
NFPA 101	
NFPA 5000	
Occupational Safety and Health Administration (OSHA) 2	

Accessibility 3

ANSI-A117.1 Accessible and Usable Buildings and Facilities	
Americans with Disabilities Act Standards for Accessible Design (ADASAD)	
Architectural Barriers Act (ABA)	

Handrail and Guard 5

Definitions	
The Ladder Effect	
Load Requirements	9
Glass Railing	10

Code Comparison Chart



International Code Council® (ICC®)

Most municipalities and local code bodies do not write code – they adopt model codes prepared by various code bodies.

Historically, model codes were prepared by code bodies such as Building Officials Code Administrators International, Inc. (BOCA) – the National Building Code (NBC); Southern Building Code Congress International (SBCCI) – the Southern Building Code (SBC); and the International Conference of Building Officials (ICBO) – the Uniform Building Code (UBC).

These various model building codes were adopted regionally by local authorities. With multiple code bodies, it was difficult to keep abreast of proposed changes by those not directly involved in the code process – e.g. architects, manufacturers and contractors.

In 1999, BOCA, SBCCI and ICBO began to work together to prepare a unified code under the auspices of the ICC.

The first set of I Codes® were published in 2000 and included the International Residential Code (IRC) and the International Building Code (IBC). The IRC applies to one and two-family dwellings while the IBC applies to commercial buildings and multi-family residential construction. The I Codes have since been adopted by states and municipalities throughout the country. They are published every three years – the most recent publication was in 2015.

The I Codes are model codes. Local code authorities generally do not have the human resources to write their own code so they adopt code using the model codes as the basis for their requirements. They may choose to adopt as is or make changes as they deem appropriate. Your local jurisdiction may also be using an older of the I Codes.

The I Codes provide minimum safeguards for people at home, at school and in the workplace. Based on your application a minimum standard may not be considered sufficient. The local authority having jurisdiction (AHJ) may reject your installation if – in their opinion – your installation is unsafe.

Always check with your local AHJ prior to proceeding with an installation.

Anyone can submit a code change but be prepared for a multi-year process that will involve attending code hearings to justify the requested change. Code books are available for purchase but you can view individual sections of the IBC and IRC on-line for free at www.iccsafe.org



National Fire Protection Association® (NFPA®)

The NFPA is a global organization devoted to eliminating death, injury, property and economic loss due to fire, electrical and related hazards. The association delivers information and knowledge through more than 300 consensus codes and standards.

There are two NFPA documents which may apply to your application – NFPA 5000: Building Construction and Safety Code and NFPA 101: Life Safety Code. NFPA 5000 was published in 2000 as an alternate to the I Codes. For the most part, it has not been adopted. However, provisions relating to handrail clearance that are different from other codes and standards have been incorporated into NFPA 101.

NFPA 101: Life Safety Code provides requirements that limit the effects of fire and related hazards. It is most likely to apply to handrail along a fire exit or fire stairs but is not applied in all instances (e.g. California does not use NFPA 101).

The NFPA is overseen and enforced by local fire marshals – not the building inspector. An installation may be approved by an inspector but rejected by the fire inspector. Always confirm requirements prior to installation. All NFPA codes may be viewed on-line for free at www.nfpa.org.



Occupational Safety and Health Administration (OSHA)

OSHA is part of the United States Department of Labor
 Pertinent section relating to handrails and guards is **1910.29**
Fall Protection Systems and Falling Object Protection -
Criteria and Practices.

These requirements primarily apply to areas not accessible
 to the public



Guard Railing:

- 42 inches - plus or minus 3 inches above walking/working surface
- Required if the "drop" is 48 inches or higher
- Intermediate rail at "about halfway up"
- Openings must be less than 19 inches
- Intermediate balusters are no more than 19 inches apart
- Must have a toe board
- Top Rails and Mid Rails must be at least .25 inches in diameter or thickness.
- Load Requirement: withstand a 200 pound load applied in a downward or outward direction within 2 inches of the top edge of the top rail.

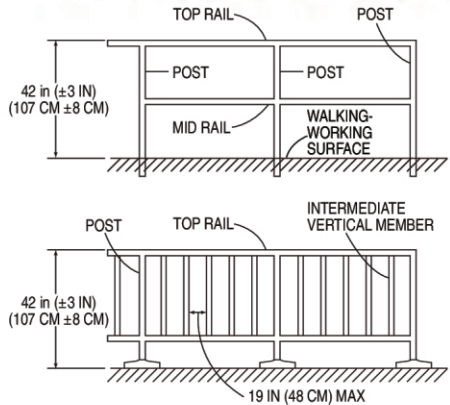

Handrail and Handrail Systems

- The minimum clearance between handrails and other objects is 2.25 inches.
- Handrails have the shape and dimension necessary to grasp firmly.
- Ends of handrail and systems do not present any projection hazards.
- Load Requirement: withstand a 200 pound load applied in a downward or outward direction within 2 inches of the top edge of the top rail.

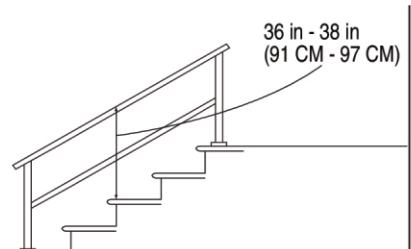
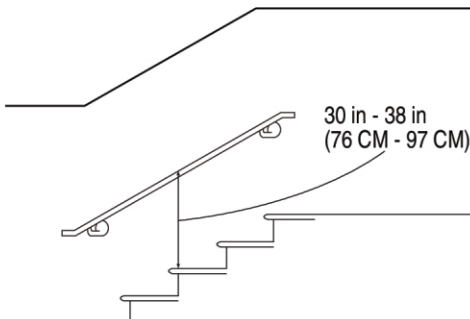

Accessibility Guidelines and Standards

There are two primary references that have been used throughout the country in relation to accessibility: ICC/ANSI A117.1, Accessible and Usable Buildings and Facilities and The Americans With Disabilities Act Accessibility Guidelines (ADAAG). ANSI A117.1 Accessible and Usable Buildings and Facilities

Originally created and published by the Council of American Building Officials (CABO) - ANSI A117.1 is now overseen by the ICC.

First published in 1986 - predating the ADA - this was considered the standard for use in designing an accessible facility. However, the 1986 publication noted an incorrect dimension for handrail. Handrail was required to be between 1 1/4" and 1 1/2" outside diameter with a clearance between the wall and handrail of 1 1/2".

Problem - these were tube sizes. The railing industry typically uses nominal pipe of 1 1/4" and 1 1/2" (actual diameter of 1.66" and 1.90", respectively) in railing as it is thicker and stronger than tube. CABO acknowledged their error as the dimensions were meant to apply to a grab bar. A correction was made and when reprinted in 1990, the handrail size was updated to allow for a diameter of between 1 1/4" and 2".

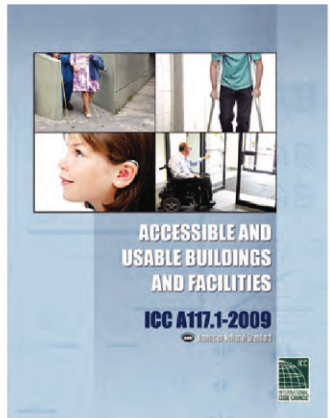

Americans With Disabilities Act (ADA)



The ADA became law in July 1990. It requires that all new places of public accommodation and commercial facilities be designed and constructed so as to be readily accessible and usable by persons with disabilities. It is overseen by the United States Access Board.

The ADA is Civil Rights Law - it prohibits discrimination on the basis of disability. Violation could subject a facility owner to a civil suit for discrimination. The ADA applies to facilities in the private sector - places of public accommodation and commercial facilities - and to state and local government facilities. The standards are issued by the Department of Justice (DOJ)

In 1991, the Americans With Disabilities Act Accessibility Guidelines (ADAAG) were prepared by The Access Board and added as an appendix to the ADA.

The Access Board did not create their own standard. They instead relied on the standards that made up ANSI A117.1. However, though ADAAG was published in 1991 - a year after the updated A117.1 - it used the 1986 standard and carried over the incorrect handrail dimensions making them federal law.

When contacted, the Access Board acknowledged the error as well but did not publish a clarification until July 1998 which allowed for 1 1/4" and 1 1/2" nominal pipe sizes (1.66" and 1.90" diameter - respectively). The Access Board announced the release of a new ADAAG in 2004. However, it was not approved by the Justice Department until July 23, 2010. The new ADA Standards for Accessible Design (ADASAD) went into effect on March 15, 2011 but was not required until March 15, 2012.

As with building codes, it is wise to confirm with your local jurisdiction as some have stricter requirements. Some states have their own accessibility standards. California, most notably, still has a requirement that handrail must have an absolute clearance between the wall and handrail of 1 1/2" (ADA notes this requirement as 1 1/2" minimum).

Architectural Barriers Act (ABA)

The ABA is similar to the ADA and also uses the ADASAD. The ABA applies to federally funded facilities - e.g., US Postal Services (USPS), Department of Defense (DOD), and Department of Housing and Urban Development (HUD). It is interesting to note that while the ADA was not approved until 2010, the ABA was approved in 2005 - shortly after the completion of the ADA review process in 2004.



Other ADA References

Protruding Objects

Objects with leading edges more than 27" and not more than 80" above the finish floor or ground shall protrude 4" maximum horizontally into the circulation path.

Exception: Handrails shall be permitted to protrude 4 1/2" maximum.

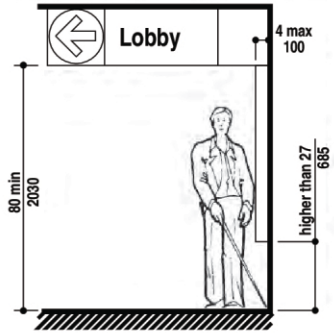

Changes in Level

- Changes in level of 1/4" high maximum shall be permitted to be vertical.
- Changes in level between 1/4" high minimum and 1/2" high maximum shall be beveled with a slope not steeper than 1:2.
- Changes in level greater than 1/2" high shall be ramped.

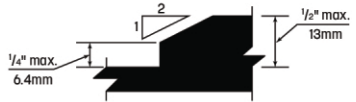

Ramps

- Ramp runs shall have a running slope not steeper than 1:12.
- Clear Width of a ramp run and, where handrails are provided, the clear width between handrails shall be 36" minimum.
- The rise for any ramp run shall be 30" maximum.
- Ramps shall have landings at the top and the bottom of each ramp run.
- A curb or barrier shall be provided that prevents the passage of a 4" diameter sphere, where any portion of the sphere is within 4" of the finish floor or ground surface.

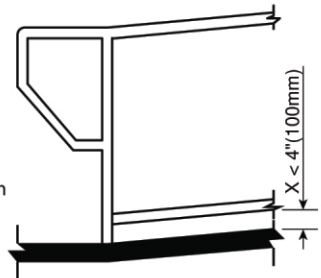

Handrail and Guard Definitions

Handrail

The purpose of a handrail is to provide guidance. It is required on stairs with two or more risers and ADA ramps with a rise of 6".

In commercial applications, handrail is required on both sides of stairs and ramps.

Handrails are not required on walking surfaces with running slope less than 1:20.

Intermediate Rails: All portions of an egress path must be within 30 inches of a handrail (will vary based on building occupancy)

Handrail Height: Placed between 34" and 38". Measurement must be taken from the stair nosing or walking surface.

For children, the 2010 ADASAD recommends a maximum height of 28" with a minimum of 9" of clearance between the child's rail and the adult rail (not required).

Handrail Continuity: Handrail must be continuous within the full length of each stair flight or ramp run. Inside handrails on switchback or dogleg stairs and ramps shall be continuous between flights or runs.

Handrails are not to be obstructed along their tops or sides.

Handrail Size Limitations: Handrail size is now consistent between all codes and standards: 1 1/4" to 2" diameter or Provide Equivalent Graspability.

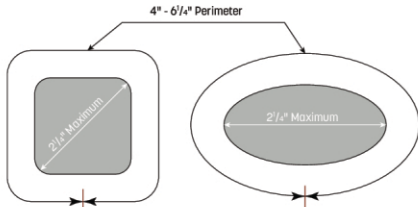
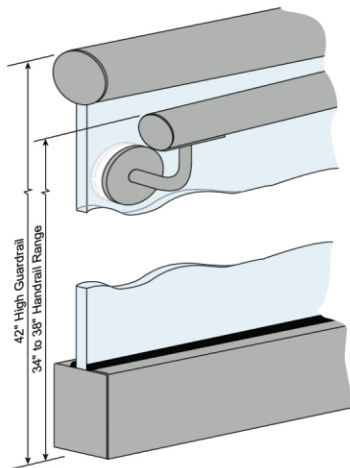

Equivalent Graspability is defined as: Handrail gripping surfaces with a non-circular cross section shall have a perimeter dimension of 4 inches (100 mm) minimum and 6" maximum, and a cross section dimension of 2 1/4" (57mm) maximum.

For Residential Applications, the ICC permits the use of larger handrail sections that meet the *Type II Definition* as noted to the right. This applies to handrail sections with a perimeter greater than 6 3/4"

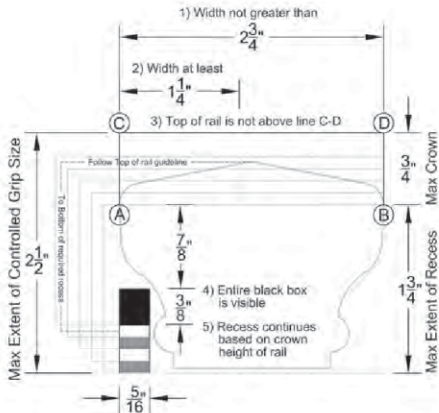
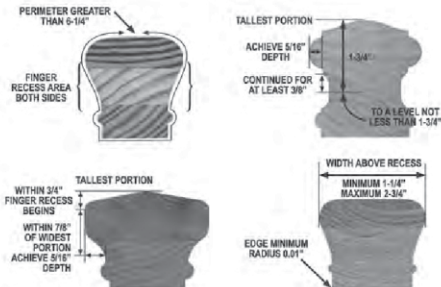

Handrail Bracket Clearance

Horizontal Clearance:

- 1991 ADAAG and California Accessibility Standard: 1 1/2" between wall and handrail.
- 2010 ADASAD, ANSI A117.1, ICC, and IRC: 1 1/2" minimum
- NFPA 101 and NFPA 5000: 2 1/4" minimum
- Maximum projection into walkway: 4 1/2"

Vertical Clearance:

- 1 1/2" clearance between the underside of the handrail and the bracket arm.
- The ICC and ADA allow for this clearance to be reduced by 1/8" for each 1/2" of perimeter over 4". Refer to table below for variation in clearance requirement based on handrail diameter.



Railing Diameter	Perimeter	Subtract From Underside of Railing	Clearance From Underside of Railing
1.25"	3.92"	0	1 1/2"
1.50"	4.71"	-1/8"	1 5/8"
1.66"	5.21"	-1/4"	1 3/4"
1.90"	5.97"	-1/2"	1"
2.00"	6.28"	-1/2"	1"



Railing Extensions Wall Mounted Ramp Rail

Ramps

Handrails extend horizontally above the landing for 12 inches minimum beyond the top and bottom of the ramp runs.

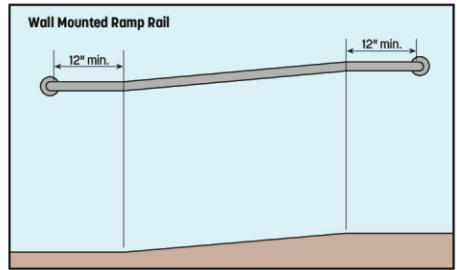

Railing Extensions

Top Extension on Stairs

Handrails extend horizontally above the landing for 12 inches minimum beginning directly above first riser nosing.

Bottom Extension on Stairs

Handrails extend at the slope of the stair flight for a horizontal distance equal to one tread depth beyond the last riser nosing.

Note: This is a relatively recent change. Some jurisdictions still require a tread depth plus 12" beyond the last riser nosing.

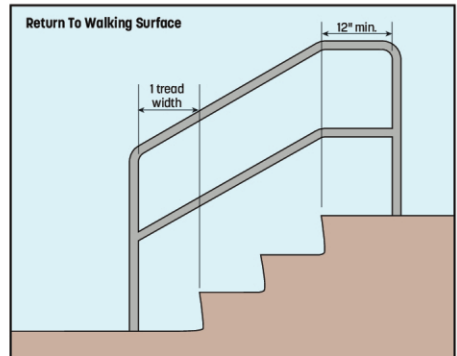

Handrail Returns

Handrail extensions must return to a wall, itself or the walking surface.

Note: While it is a common practice to leave a gap between a wall return and the wall, some inspectors have rejected this as they consider it a return *toward* the wall and not a return *to* the wall.

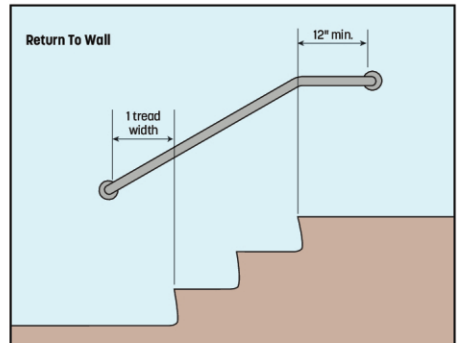
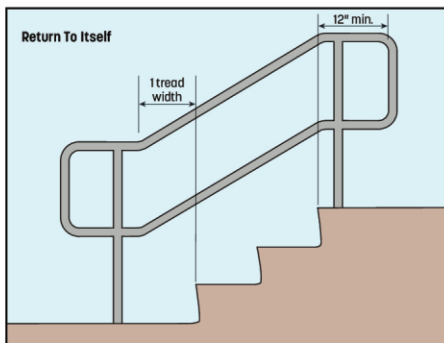

Guard

Guards are in place to prevent *accidental falls*. They are generally not required unless there is a 30" drop - which may vary by local AHJ.

In residential applications, the guard height minimum is 36". On a stair, since handrail must be between 34" and 38", the handrail and the top of the guard can be one and the same.

In commercial applications, the IBC requires a minimum height of 42". On stairs, once there is a 30" drop, a handrail will be required and placed between 34" and 38" above the nosing.

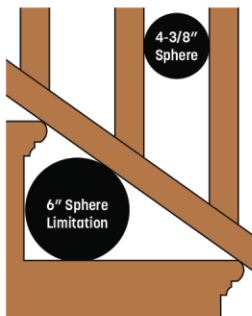

4" sphere rule - no opening large enough to pass a 4" sphere is permitted.
 Exceptions: 4 3/8" opening on stairs and 6" opening in the triangular area between a bottom rail and tread



The Ladder Effect

While there are some local codes that still contain wording relating to *The Ladder Effect*, there is no such wording in any of the current model codes.

The original Ladder Effect reference stated: *Required guards shall not be constructed with horizontal rails or other ornamental pattern that result in a ladder effect*

This wording first appeared in BOCA's National Building Code in 1993. When the code bodies joined together in 1999, it was proposed and added to the 2000 IRC - it was successfully blocked from the IBC.

The decision was based on perception not reality. No hard evidence was ever presented to indicate there was an epidemic of injuries to young children related to climbing. The ICC defines a guard as being in place to prevent an accidental fall - climbing is not an accident. In fact, a review of accident reports often noted that the child had climbed a chair or similar item placed on a balcony and not the guard itself.

Climbability is addressed in the model codes under the definitions for *Barrier* which appear in the pool barrier section of the appendix.

A pool barrier requires a 48" minimum height with smaller opening limitations and other restrictions specifically to limit climbability.

The Ladder Effect wording was removed from the IRC in 2001 and it has not been a part of the model codes since that time. However, it has been applied on a local basis with some jurisdictions choosing to add it to their local codes - e.g., Chicago, Baltimore, Pittsburgh, and Washington D.C.



The ICC's concern over this issue was such that in 2004 they tasked the ICC Code Technology Committee (CTC) to determine how to make guards less climbable - if necessary.

Initial focus was on the discrepancy between the data analysis provided by the proponent for climbing restrictions and the railing industry.

In 2007, the National Ornamental and Miscellaneous Metals Association (NOMMA) commissioned the National Association of Home Builders' (NAHB) Research Center to review all existing peer reviewed reports and Consumer Product Safety Commission (CPSC) data and assemble an independent report on the issue of guard climbability.

The report was completed in September 2007 - *Fall Safety of Children Between the Ages of Eighteen Months and Four Years in Relation to Guards and Climbing in the Built Environment*.

Over 40 peer-reviewed studies were examined for the report covering the areas of children's physical development and their interaction with the built environment. The review of the studies resulted in this set of conclusions:

- *The human child is built to climb and loves to do so! (Readdick and Park, 1998).*
- *Climbing is involved in the child's physical, psychological and social development.*
- *Climbing skills are often taught and encouraged by parents, especially with boys.*
- *Climbing is a part of physical education at school.*
- *No evidence of a gender difference in either climbing skill or climbing speed in young children.*
- *Difficult barrier designs merely present a greater challenge to the determined child.*
- *Studies also generally agree that it is probably impossible and most likely undesirable to render any environment completely "safe" from children's climbing*

The NAHB Research Center's review went on to analyze CPSC data collected by the National Electronic Injury Surveillance System (NEISS) Data. Previous analysis of this data had been unscientific and inconclusive. Following a thorough, scientific analysis, the review of NEISS data resulted in the following conclusions:

- *The results indicate that falls from Porches, Balconies, Open-Side Floors, Floor Openings Handrails, Railings, Banisters among young children aged 18 months to 4 years account for an estimated 0.032 percent of injuries in that population.*
- *The incident rate is approximately 2.5 per 100,000 children between 18 months and 4 years of age*
- *There is much uncertainty in the data to ascribe causality or the physical situation that lead to reported injuries. The CTC's conclusion was that the low incidence rate did not warrant the creation of code language. No Ladder Effect wording is present in the current IRC or IBC.*

Always check with your local AHJ to determine if they have some variation of this wording in their requirements.



Load Requirements

Handrails and Guards must be able to withstand a Uniform Load of 50 lbs/ft or a Concentrated Load of 200 lbs placed at the top of the handrail or guard.

Infill areas must be able to withstand a load of 50 lbs/sq.ft.

See information below regarding the unique requirements of glass railing systems.

Inspectors do not have the ability to confirm this visually and they are not equipped to field test a railing for compliance. Therefore it has become more common to find that they are requesting engineering data or test reports to confirm that the installation meets the load requirements.

Is a Top Railing Required on Glass Baluster Railing?

The photo to the left is typical of many glass railing installations without a top rail. In this application, a non-required handrail has been attached to the glass based on an interpretation of the original glass railing code:

IBC 2407.1.2 Each handrail or guard section shall be supported by a minimum of three glass balusters or shall be supported to remain in place should one baluster panel fail. Glass balusters shall not be installed without an attached handrail or guard.

This code was poorly written as the code should have read *without an attached handrail or top rail*. Subsequent codes were updated to note exceptions which eliminated the need for a top rail of laminated, tempered glass was supplied but confusion remained.

However, the 2015 IBC has provided a very specific answer to this question.

Section 2407.1.2 Support - *Each handrail or guard section shall be supported by a minimum of three glass balusters or shall be otherwise supported to remain in place should one baluster fail. Glass balusters shall not be installed without an attached handrail or guard.*

Exception - A top rail shall not be required where the glass balusters are laminated glass with two or more glass plies of equal thickness and the same glass type when approved by the building official. The panels shall be designed to withstand the loads specified in Section 1607.8.

The IBC also notes a Glass Railing specific Load Requirement:

IBC 2407.1.1 Loads. *The panels and their support system shall be designed to withstand the loads specified in section 1607.8. A design factor of four shall be used for safety.*

All Guard and Handrail Requirements:

IBC1607.8.1 Handrails and guards. *Handrail assemblies and guards shall be designed to resist a linear load of 50 pounds per linear foot (plf) (0.73 kN/m) in accordance with Section 4.5.1 of ASCE 7 . . .*

IBC1607.8.1.1 Concentrated Load. *Handrails and guards shall be designed to resist a concentrated load of 200 pounds (0.89kN), in accordance with Section 4.5.1 of ASCE 7.*

ASCE7 notes the load needs to be placed at the "top" of the guard. The handrail is not the top of the guard. It is unlikely that the bare edge of tempered glass will be able to withstand a 200 lb concentrated load with a design factor of four.

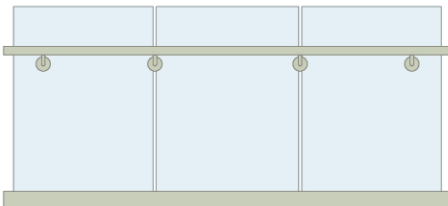

Glass balustrade with No Top Rail - must be approved by the local code official.

Municipal and state authorities generally do not write their own code. They use model codes to create documents for use in their local jurisdictions.

Not all fabrications need to meet building codes – some installations may be considered ornamental in nature.

ADAAG – Americans With Disabilities Act Accessibility Guidelines (1991).

ADASAD – Americans With Disabilities Act Standards for Accessible Design (2010).

ANSI – American National Standards Institute.

IBC – International Building Code.

IRC – International Residential Code.

Guard Location Requirements

IRC	<ul style="list-style-type: none"> • 30" above floor or grade below on open-sided walking surfaces. • On open sides of stairs with a total riser of more than 30" above the floor or grade below.
IBC	<ul style="list-style-type: none"> • 30" above floor or grade below on open-sided walking surfaces, mezzanines, industrial equipment platforms, stairways, ramps and landings. • 30" above floor or grade below along glazed sides of stairways, ramps and landings where the glazing provided does not meet the code's strength and attachment requirements.
IRC 2009 IBC 2009	Amended to add the following: Measurement for the 30" drop is to be taken at any point within 36" from the edge of the open surface.

Height Requirements, Minimum for Guards

IRC	<ul style="list-style-type: none"> • 36" minimum on porches, balconies, raised floor surfaces. • 34" minimum on open side of stairs.
IBC	42" minimum except in Group R-3, and within individual dwelling units of Group R-2. In those applications, where the top rail also serves as a handrail, it shall have a height of not less than 34" and not more than 38" above stair nosing.
IBC 2001	Amended to add the following: <ul style="list-style-type: none"> • The height in assembly seating areas shall be in accordance with Section 1008.12.
IBC 2006	Amended to add the following: <ul style="list-style-type: none"> • In assembly seating where guards in accordance with Section 1025.14 are permitted and provided.

Height Requirements of Guards For Balconies, Galleries & Bleachers

IBC 2000	All portions of the stairway width required for egress capacity are within 30" of a handrail.
IBC 2003	Amended to add the following: <ul style="list-style-type: none"> • Intermediate handrails are required so that all portions of the stairway width required for egress capacity are within 30" of a handrail. • On monumental stairs, handrails shall be located along the most direct path of egress travel.

Allowable Opening for Guards, Maximum

IRC	<ul style="list-style-type: none"> • 4" sphere – general. • 6" sphere – at triangle formed by riser, tread and bottom rail.
IRC 2000	Required guards shall not be constructed with horizontal rails or other ornamental pattern that results in a ladder effect.
IRC 2001	<i>Ladder Effect removed.</i>
IRC 2003	4 ^{3/8} " sphere for openings on the sides of stair treads.
IBC 2000	<ul style="list-style-type: none"> • 4" sphere – general – to a height of 34". • 6" sphere – at triangle formed by riser, tread and bottom rail. • 8" sphere from a height of 34" to 42". • Exceptions: 2" sphere for elevated walk for electrical, mechanical and plumbing systems and Group I-3, F, H or S occupancies, balusters, horizontal intermediate rails or other construction.
IBC 2003	<ul style="list-style-type: none"> • In areas which are not open to the public within occupancies in Group I-3, F, H or S, balusters, horizontal intermediate rails or other construction shall not permit a sphere with a diameter of 2" to pass through any opening. • In assembly seating areas, guards at the end of aisles – where they terminate at a fascia of boxes, balconies and galleries – shall have balusters or ornamental patterns such that a 4" sphere cannot pass through any opening up to a height of 26". From a height of 26" to 42" above the adjacent walking surfaces, a sphere 8" in diameter shall not pass.
IBC 2006	4 ^{3/8} " sphere for openings on the sides of stair treads in Group R-3 and within individual dwelling units of Group R-2.
IBC 2009	<ul style="list-style-type: none"> • 4" sphere – general – to a height of 36". • 6" sphere – at triangle formed by riser, tread and bottom rail. • 4^{3/8}" sphere from a height of 36" to 42".

Glass Railing

IBC	<ul style="list-style-type: none"> • Each handrail or guard section shall be supported by a minimum of three glass balusters or shall be supported to remain in place should one baluster panel fail. Glass balusters shall not be installed without an attached handrail or guard. • The panels and their support system shall be designed to withstand the uniform or concentrated load requirements – applied at the top – by a design factor of 4 for safety.
IBC 2012	<ul style="list-style-type: none"> • If the top rail is only supported by glass, the assembly shall be tested according to the impact requirements in ASTM E 1996. The impacted glass shall be able to support the top rail after impact. • A top rail shall not be required where the glass balusters are laminated glass with two or more glass plies of equal thickness and the same glass type when approved by the building official. The panels shall be designed to withstand the structural load as required by code. • Glass installed in exterior railing in-fill panels or balusters shall be laminated glass complying with Category II of CPSC 16 CFR 1201.
IBC 2015	<ul style="list-style-type: none"> • Laminated, tempered glass is required in all glass railing applications. No top rail is required if approved by the local code official.

Handrail Location Requirements

IRC 2000	<ul style="list-style-type: none"> Handrails required on at least one side of ramps exceeding a slope of 1:12. Handrail required on at least one side of stairway.
IRC 2003	<ul style="list-style-type: none"> Handrail required on at least one side of stairway with two or more risers. Handrails shall be provided on at least one side of each continuous run of treads or flight with four or more risers.
IBC 2000	<ul style="list-style-type: none"> Handrails required on both sides of stairs and ramps. All portions of the stairway width required for egress capacity are to be within 30" of a handrail.
IBC 2003	<ul style="list-style-type: none"> Aisle stairs provided with a center handrail need not have additional handrails. Stairways within dwelling units, spiral stairways and aisle stairs serving seating only on one side are permitted to have a handrail on one side only. Decks, patios and walkways that have a single change in elevation where the landing depth on each side of the change of elevation is greater than what is required for a landing do not require handrails. In Group R-3 occupancies, a change in elevation consisting of a single riser at an entrance or egress door does not require handrails. Changes in room elevations of only one riser within dwelling units and sleeping units in Group R-2 and R-3 occupancies do not require handrails. Intermediate handrails are required so that all portions of the stairway width required for egress capacity are within 30" of a handrail. On monumental stairs, handrails shall be located along the most direct path of egress travel.
ANSI A117.1	<p>Handrails required on both sides of stairs and ramps.</p> <ul style="list-style-type: none"> Exception: aisle stairs and aisle ramps provided with a handrail either at the side or within the aisle width.
ADASAD	<ul style="list-style-type: none"> Ramps - both sides, if rise exceeds 6" or a horizontal length more than 72". Not required next to seating in assembly areas. Stairs - both sides.

Intermediate Handrail Requirements

IBC 2000	All portions of the stairway width required for egress capacity are within 30" of a handrail.
IBC 2003	Intermediate handrails are required so that all portions of the stairway width required for egress capacity are within 30" of a handrail. On monumental stairs, handrails shall be located along the most direct path of egress travel.

Grip Size, Handrails

IRC 2000	<ul style="list-style-type: none"> Circular shapes: 1 1/4" minimum; 2 3/4" maximum. Non-Circular: Other shapes that provide an equivalent grasping surface are permissible. Edges shall have 1/8" minimum radius.
IRC 2001	<ul style="list-style-type: none"> Type I: Circular shapes: 1 1/4" minimum; 2 3/4" maximum. Type 2: Handrails with a perimeter greater than 6 1/4" shall provide a graspable finger recess area on both sides of the profile. The finger recess shall begin within a distance of 3/4" vertically from the tallest portion of the profile and achieve a depth of at least 3/8" within 7/8" below the widest portion of the profile. This required depth shall continue for at least 3/4" to a level that is not less than 1 1/4" below the tallest portion of the profile. The minimum width of the handrail above the recess shall be 1 1/4" to a maximum of 2 3/4". Edges shall have a minimum radius of .01".
IRC	<ul style="list-style-type: none"> Type I: Handrails with a circular cross section shall have an outside diameter of at least 1 1/4" and not greater than 2 inches. If the handrail is not circular it shall have a perimeter dimension of at least 4" and not greater than 6 1/4" with a maximum cross section dimension of 2 1/4". Type II: Handrails with a perimeter greater than 6 1/4" shall provide a graspable finger recess area on both sides of the profile. The finger recess shall begin within a distance of 3/4" measured vertically from the tallest portion of the profile and achieve a depth of at least 5/8" within 7/8" below the widest portion of the profile. This required depth shall continue for at least 3/4" to a level that is not less than 1 1/4" below the tallest portion of the profile. The minimum width of the handrail above the recess shall be 1 1/4" to a maximum of 2 3/4". Edges shall have a minimum radius of .01".
IBC ANSI A117.1 ADASAD	<ul style="list-style-type: none"> Circular shapes: 1 1/4" minimum; 2" maximum. Non-Circular: Perimeter dimension of 4" minimum and 6 1/4" maximum with a 2 1/4" maximum cross-section - see detail below. Edges are noted as 1/8" minimum radius for IBC 2000; 0" minimum radius for IBC 2003 and later; and rounded for ADAAG and ADASAD.
IBC	For Group R-3 and within individual dwelling units of Group R-2, Type II handrail is also permitted as defined in IRC 2003, 2006 and 2009 above.

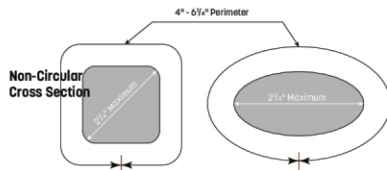

Clearance, Handrails

IRC IBC ANSI A117.1 ADASAD	1½" From wall, minimum.
NFPA 101	2¼" From wall, minimum. Note: Many jurisdictions have modified this requirement to 1½" when adopted. Contact your local authority having jurisdiction to verify.
IBC 2003	Handrail brackets or balusters attached to the bottom surface of the handrail that do not project horizontally beyond the sides of the handrail within 1½" of the bottom of the handrail shall not be considered to be obstructions and provided further that for each ½" of additional handrail perimeter dimension above 4", the vertical clearance dimension of 1½" shall be permitted to be reduced by ¼". Refer to page 227.

Project from Wall, Handrails

IRC IBC ANSI A117.1 ADASAD	4½" from wall, maximum, into the area of traffic.
-------------------------------------	---

Height Requirements, Minimum for Handrails

IRC IBC ANSI A117.1	34" minimum; 38" maximum - measured vertically above stair nosings and ramp surfaces.
IRC 2003	34" minimum; 38" maximum - measured vertically from the sloped plane adjoining the tread nosing, or finish surface of ramp slope.
ADASAD	38" maximum. ADAAG Advisory: <i>The requirements for stair and ramp handrails in this document are for adults. When children are the principle users in a building or facility (e.g., elementary schools), a second set of handrails at an appropriate height can assist them and aid in preventing accidents. A maximum height of 28 inches (710 mm) measured to the top of the gripping surface from the ramp surface or stair nosing is recommended for handrails designed for children. Sufficient vertical clearance between upper and lower handrails, 9 inches (230 mm) minimum, should be provided to help prevent entrapment.</i>

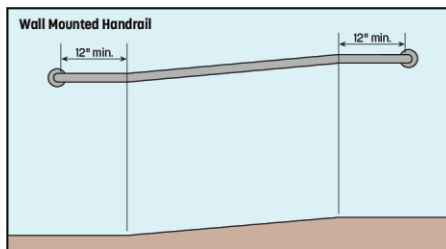

Handrail Continuity Requirements

IRC	Handrails for stairways shall be continuous for the full length of the flight, from a point directly above the top riser of the flight to a point directly above lowest riser of the flight. Handrail ends shall be returned or shall terminate in newel posts or safety terminals. • Exceptions: 1. Handrails shall be permitted to be interrupted by a newel post at the turn. 2. The use of a volute, turnout, starting easing or starting newel shall be allowed over the lowest tread.
IBC	Handrail-gripping surfaces shall be continuous, without interruption by newel posts or other obstructions. • Exceptions: 1. Handrails within dwelling units are permitted to be interrupted by a newel post at a stair landing. 2. Within a dwelling unit, the use of a volute, turnout or starting easing is allowed on the lowest tread. 3. Handrail brackets or balusters attached to the bottom surface of the handrail that do not project horizontally beyond the sides of the handrail within 1½" of the bottom of the handrail shall not be considered to be obstructions and provided further that for each ½" of additional handrail perimeter dimension above 4", the vertical clearance dimension of 1½" shall be permitted to be reduced by ¼". Refer to page 227.

Handrail Extension Requirements, Top of Stairs

IBC ANSI A117.1 ADASAD	12" horizontally beyond top stair riser - measure to the inside face of the handrail return.
IRC	Not required.

Handrail Extension Requirements, Bottom of Stairs

IBC ANSI A117.1 ADASAD 2010	Handrail shall extend at the slope of the stair flight for a horizontal distance equal to one tread depth beyond the last riser nosing - measure to the inside face of the handrail return.
IRC	Not required.

Handrail Extension Requirements, Ramps

IBC ANSI A117.1 ADASAD 2010	12" horizontally at both top and bottom of ramp runs - measure to the inside face of the handrail return.
-----------------------------------	---

End Details, Handrails

IRC 2000	Ends shall return or shall terminate in newel posts or safety terminals.
IBC 2000 ANSI A117.1 ADASAD 2010	Return to wall, guard or the walking surface or continuous to the handrail of an adjacent stair flight. Return smoothly to walls, post or floors.

Live Load, Uniform

IRC	<ul style="list-style-type: none"> • 200 lb. Uniform live load. • 50 lbs/sqft horizontally applied normal load for guard in-fill components (all those except the handrail), balusters and panel fillers. This load need not be assumed to act concurrently with any other live load requirement.
IBC 2001	50 lbs/ft in any direction (handrails and guards).
IBC	<ul style="list-style-type: none"> • Handrail assemblies and guards shall be designed to resist a load of 50 plf applied in any direction at the top and to transfer this load through the supports to the structure. • Intermediate rails (all those except the handrail), balusters and panel fillers shall be designed to withstand a horizontally applied normal load of 50 pounds on an area equal to 1 square foot, including openings and space between rails. Reactions due to this loading are not required to be superimposed with those of Section I607.7.1 or I607.7.1.1.

Live Load, Concentrated

IRC 2000	200 lbs.
IRC 2003	200 lb uniform live load. A single concentrated load applied in any direction at any point along the top.
IBC 2001	200 lbs in any direction (handrails and guards).
IBC 2003	Handrail assemblies and guards shall be able to resist a single concentrated load of 200 pounds, applied in any direction at any point along the top, and have attachment devices and supporting structure to transfer this loading to appropriate structural elements of the building.
ANSI A117.1	250 lbs (grab bars for toilets, tubs and showers).

You may view present and past ICC codes - as well as state codes - for free at:

www.iccsafe.org/Store/Pages/FreeCodes.aspx.



Lumenrail® with Cable Rail Infill